

### Application Note PE017

1	Measure magnetic field on different objects.....	2
1.1	Measure the surface flux density of a permanent magnet.....	2
1.2	Measure the polarity of a permanent magnet.....	3
1.3	Measure the field of a coil.....	4
1.4	Measure the field in an air gap.....	6
1.5	Measure the stray field of a transformer.....	7
1.6	Earth Magnetic Field Measure.....	8
1.7	Field of Helmholtz coils pairs.....	9
1.8	Measure residual magnetism.....	10
2	Measurement setup.....	11
2.1	FM 302 and probe.....	11
2.2	Extended use of the FM 302.....	11
2.3	Several probes.....	12
2.4	Autonomous operation of the AS active probes.....	13
2.5	Operation of AS active probes with AS probe adapter.....	13

---

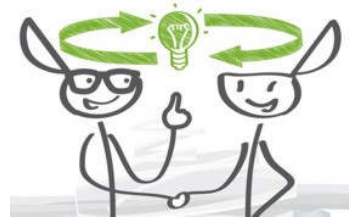

## Measurement of magnetic fields

### 1 Measure magnetic field on different objects

#### 1.1 Measure the surface flux density of a permanent magnet

The surface flux density of a permanent magnet may be e.g. be measured with a transversal AS-NTM or an axial AS-NAP probe

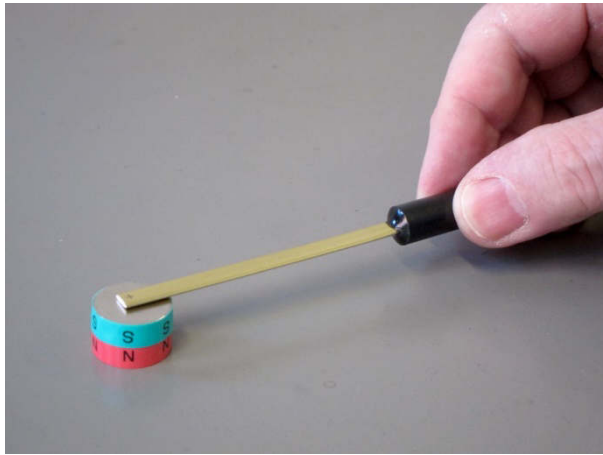

The transversal probe is placed flat on the magnet for measurement, as only the field component is measured vertically through the probe.

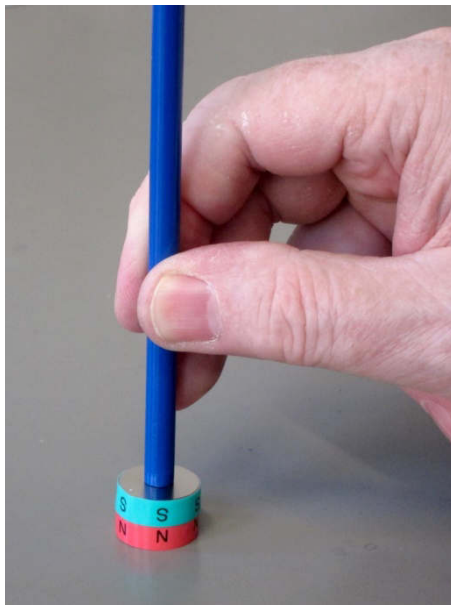

In contrast, the axial probes are placed perpendicular to the magnet for measurement, since this probe measures only the field component parallel to the probe.

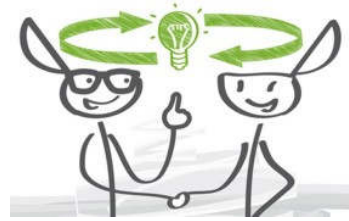

## Measurement of magnetic fields

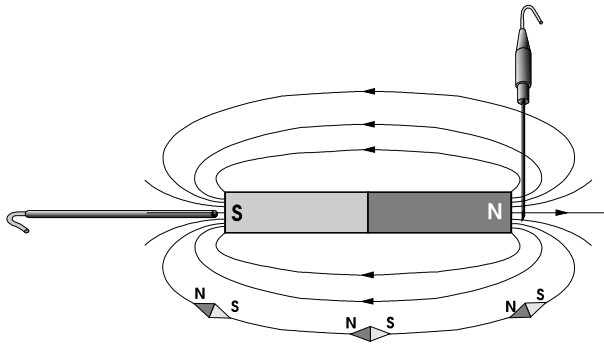

The adjacent diagram once again illustrates the course of the field lines.

### 1.2 Measure the polarity of a permanent magnet

If the surface flux density of a magnet is measured in accordance with the previous chapter, then the polarity of the magnet can also be determined from the sign of the displayed value. The two following graphics show the field direction for a positive display value.

For the transverse probes, the field lines must pass through the engraved cross or the white ceramic surface.

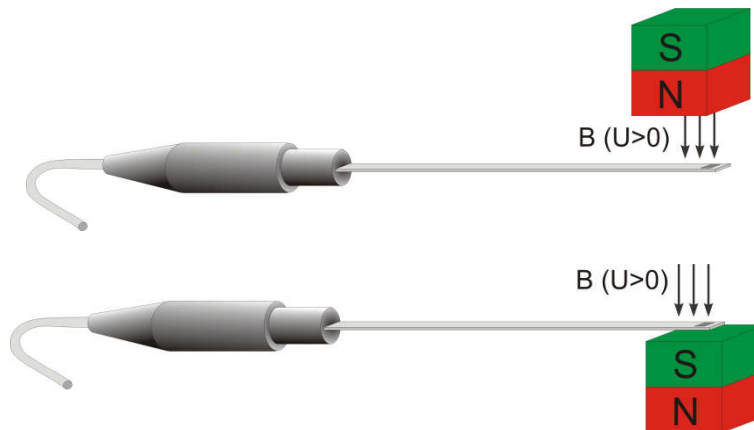

For the axial probes, the field lines must be in the direction of the probe.



If a transversal probe is now placed with the cross up on a magnet or if the axial probes are mounted vertically on a magnet and the teslameter shows a positive value, then there is a south pole underneath the probe. If a negative value is displayed, it is the north pole.

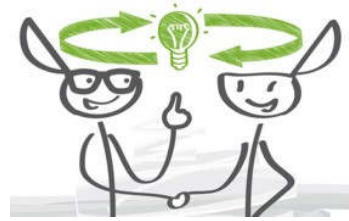

## Measurement of magnetic fields

### 1.3 Measure the field of a coil

With a transversal probe, only the output flux density of a coil can be measured.

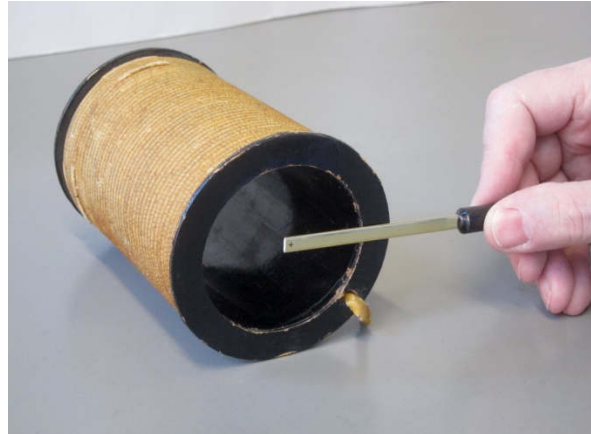
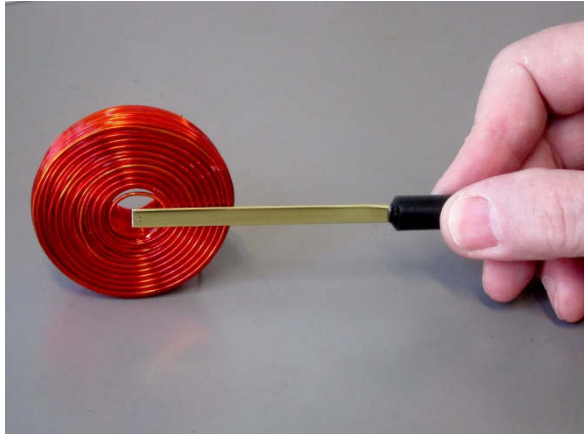

By contrast, an axial probe can also be used to measure the field inside a coil.

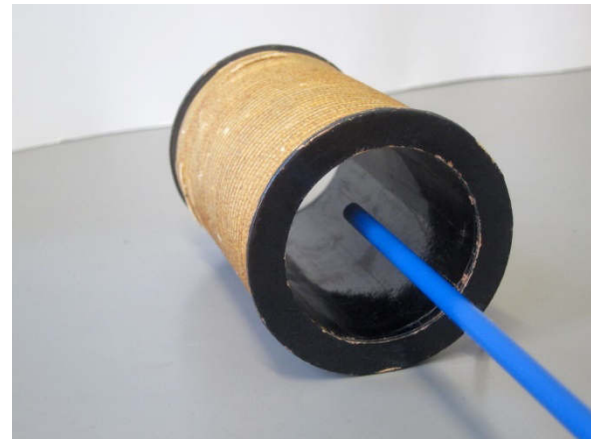

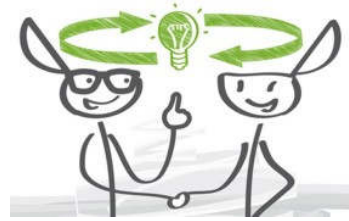

## Measurement of magnetic fields

The stray field of a coil can be measured with both probe types.

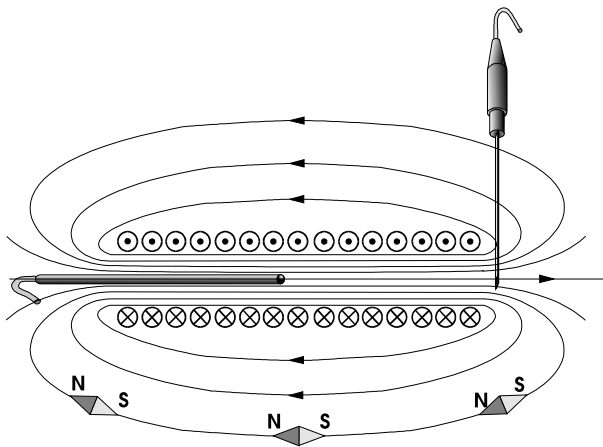
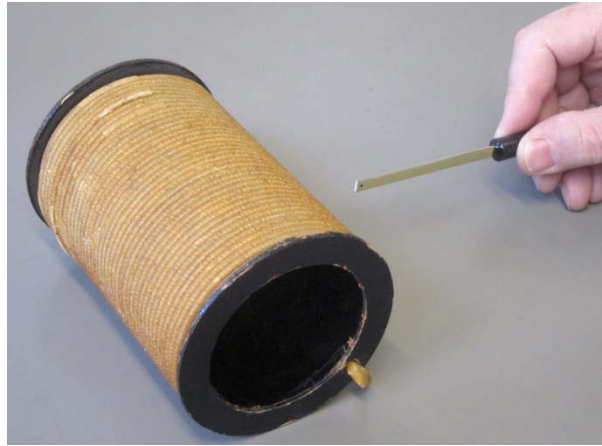
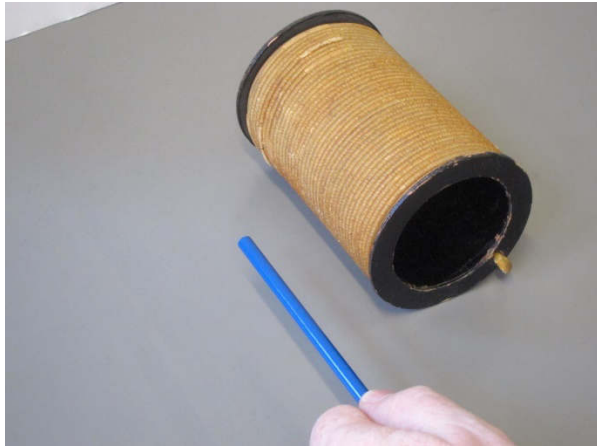

The field line course makes clear here, too, the adjacent graphic.

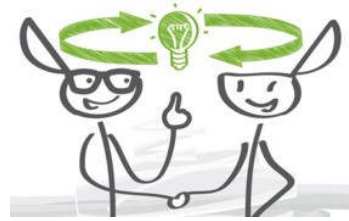

## Measurement of magnetic fields

### 1.4 Measure the field in an air gap

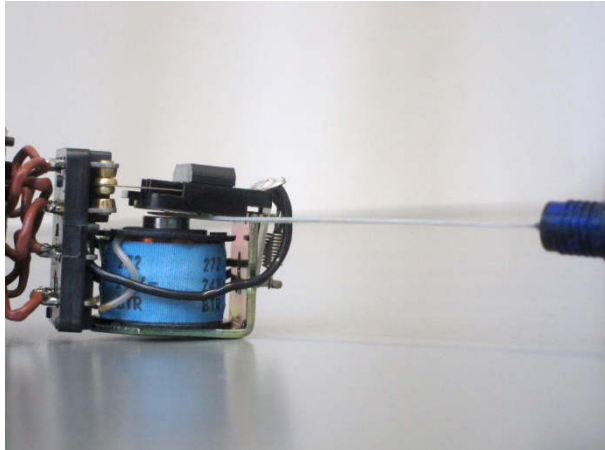

To be able to measure in narrow air gaps, relays or contactors, a thin transversal probe like the AS-NTP is needed.



Even thinner and, moreover, even more flexible is the probe AS-NTP Flex, which can thus be used, for example, in suitable for measuring in air gaps of loudspeakers.



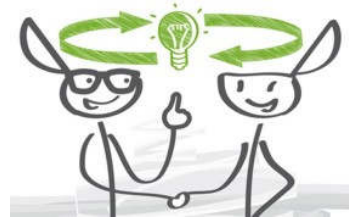

## Measurement of magnetic fields

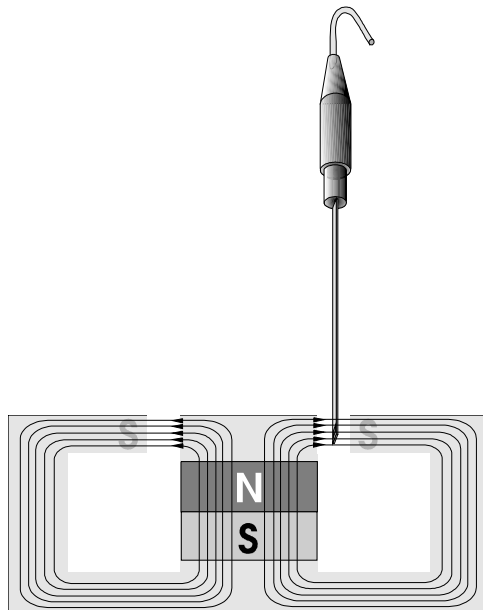

The adjoining picture shows the measurement again in a schematic representation.

### 1.5 Measure the stray field of a transformer

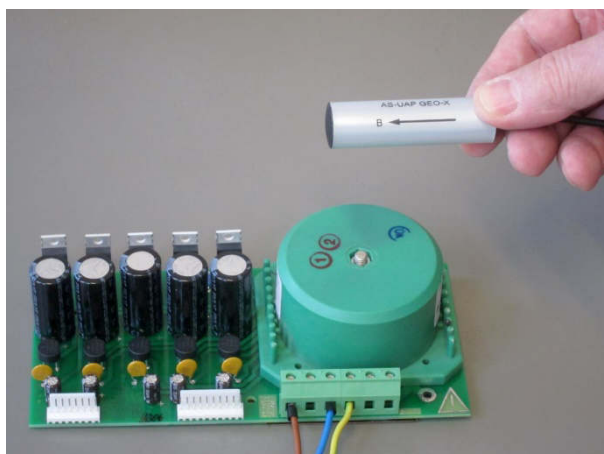

To measure the rather weak stray field of a transformer, a sensitive probe like the AS UAP GEO X is necessary.

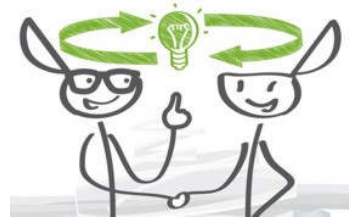

## Measurement of magnetic fields

### 1.6 Earth Magnetic Field Measure

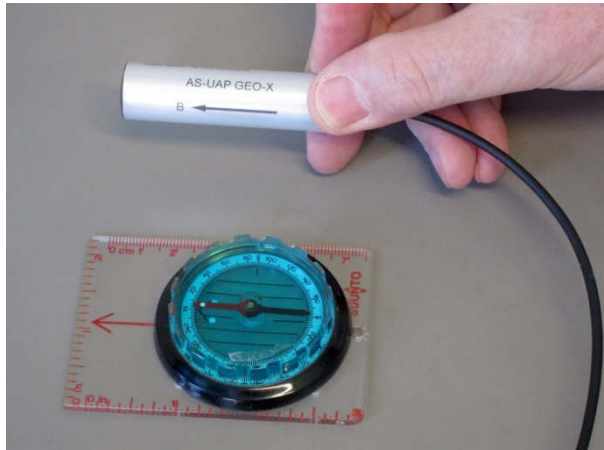

To measure the earth's magnetic field, a very sensitive probe is necessary. This sensitivity is achieved by the AS-UAP probes.

For general measurements we recommend the AS UAP GEO X.

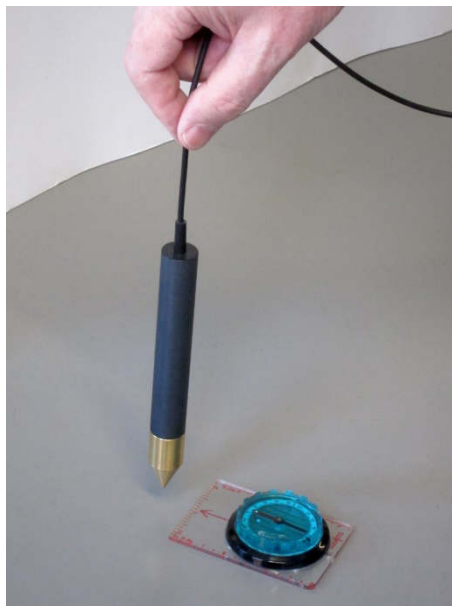

For measuring the vertical component of the Earth's magnetic field, on the other hand, the probe AS UAP Lot offers itself. This can be used hanging like a solder on the cable.

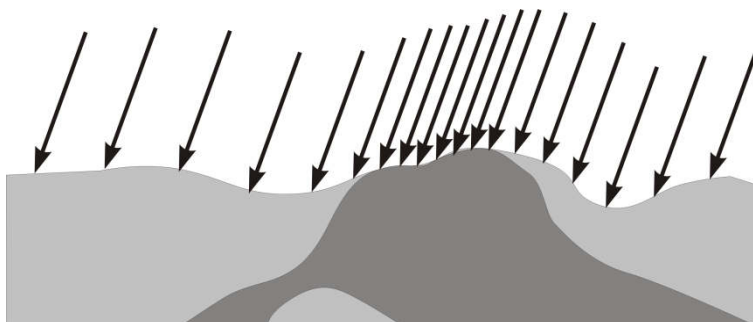

Changes in the Earth's magnetic field, as e.g. caused by geological inhomogeneities can be measured with this probe.



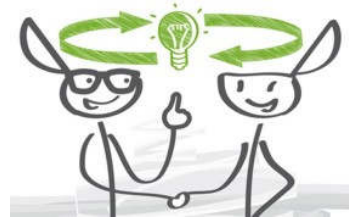

## Measurement of magnetic fields

### 1.7 Field of Helmholtz coils pairs

For small Helmholtz coils, which can only generate a weak field, the measurement with the sensitive AS-UAP GEO-X probe is ideal. For stronger coils, the axial probe AS-LAP can be used.



Since the interior space is accessible from the side between the two coils, it is also possible to measure with a transversal probe. If the coil diameter is large enough, it is also possible to place the probe inside the coil.



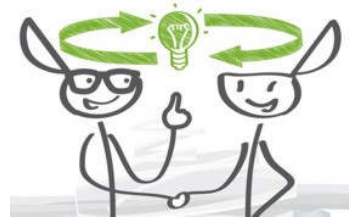

## Measurement of magnetic fields

### 1.8 Measure residual magnetism

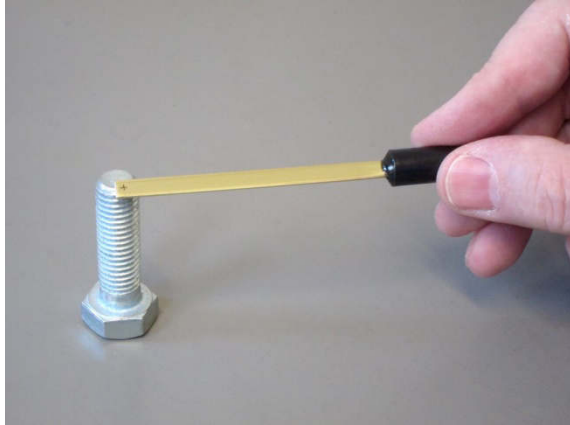

To measure the residual magnetism of workpieces, the workpiece is traversed with the mounted probe (axially or transversely).

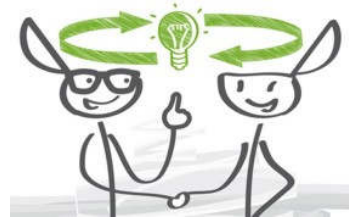

## Measurement of magnetic fields

## 2 Measurement setup

### 2.1 FM 302 and probe

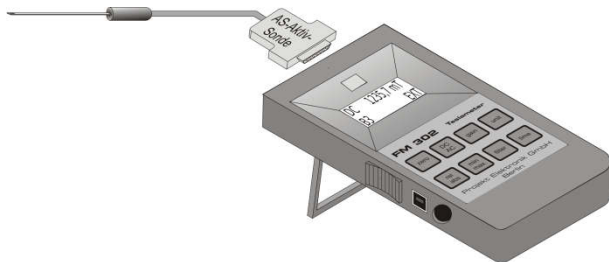

In the simplest case, only the Teslameter FM 302 and an AS active probe are needed for the measurement.

### 2.2 Extended use of the FM 302

In addition, an oscilloscope can be connected to the analog output of the Teslameter FM 302. The USB connection allows the FM 302 to be connected to a PC. This can be used to control the device and read the measured value. At the same time, the FM 302 is also powered by it. Alternatively, the FM 302 can also be supplied via a plug-in power supply.

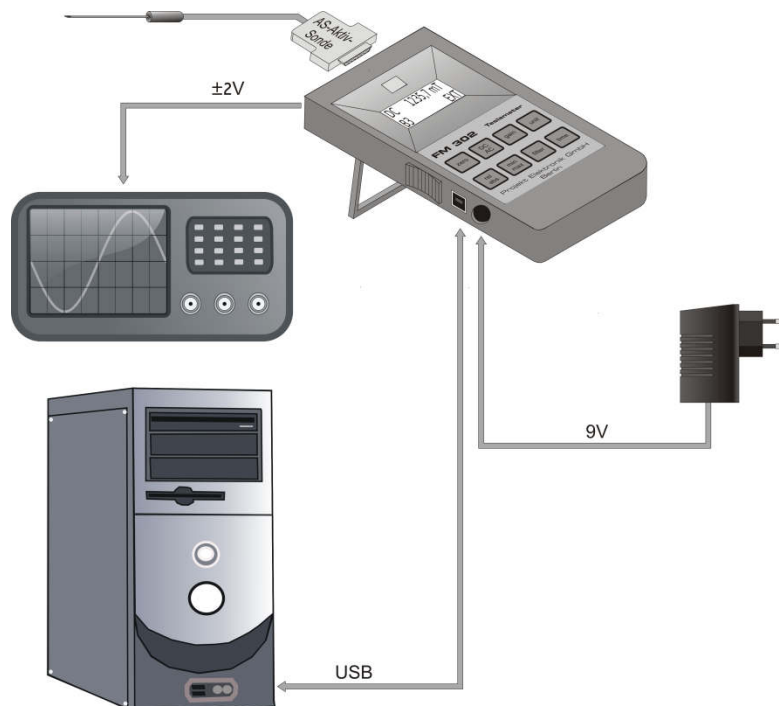

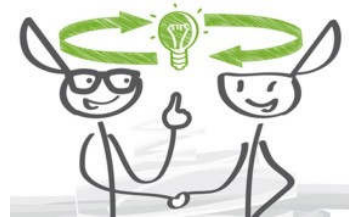

## Measurement of magnetic fields

### 2.3 Several probes

If several probes are to be used simultaneously, the interface IAS 4 can be used for this. This offers the possibility to supply up to 4 probes. IAS 4 provides the analog outputs of the probes for further evaluation, e.g. ready on an oscilloscope or via an A / D converter card.

As a control instrument also a Teslameter FM 302 can be connected.

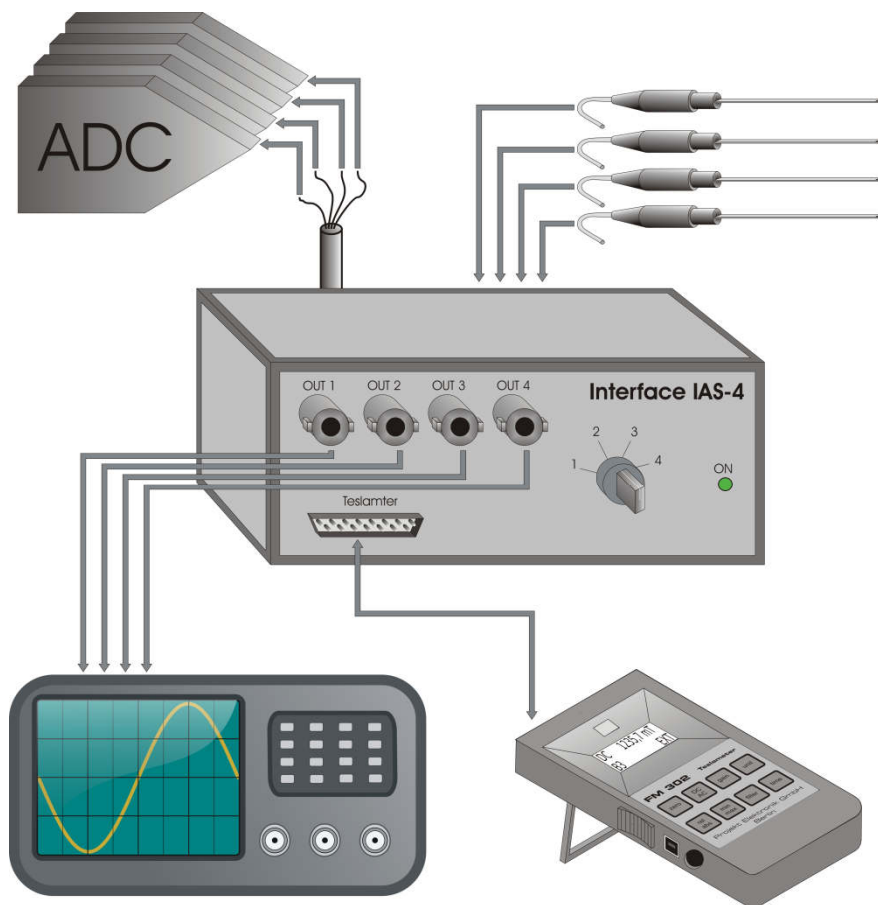

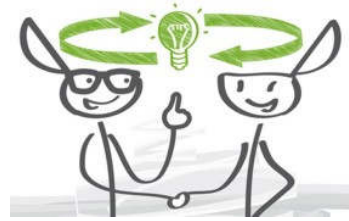

## Measurement of magnetic fields

### 2.4 Autonomous operation of the AS active probes

The AS active probes can also be operated without a Teslameter. For this, the probe must be supplied with  $\pm 3V$  (or 6V). The probes provide as output a voltage proportional to the measured field. This output may then be e.g. be further processed with a PLC.

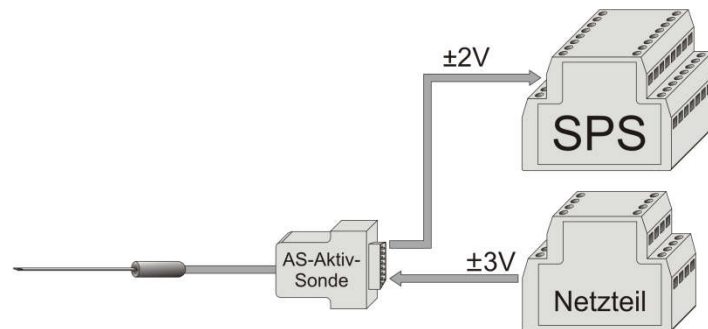

### 2.5 Operation of AS active probes with AS probe adapter

To simplify the operation of an AS active probe on a PLC, the AS probe adapter can be used. This provides the  $\pm 3V$  for the supply of the probe with high precision. In addition, the output signal of the probe will be amplified to a level of  $\pm 10V$ , which is typical for the analog inputs of PLC systems.

